

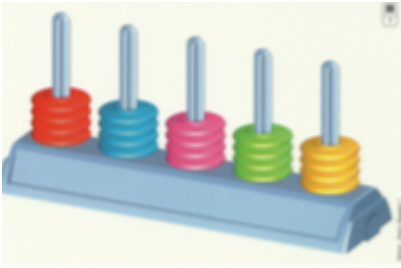

# Défi ATELIER ABAQUES 1

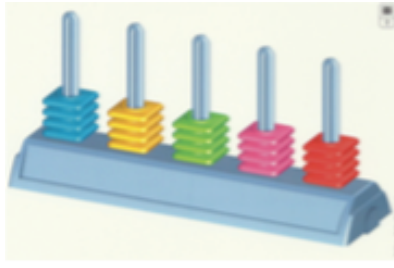

1



2

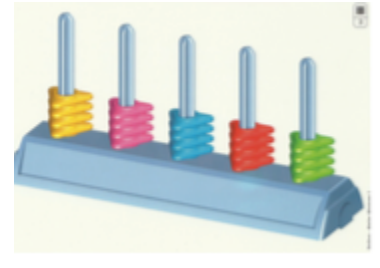

3

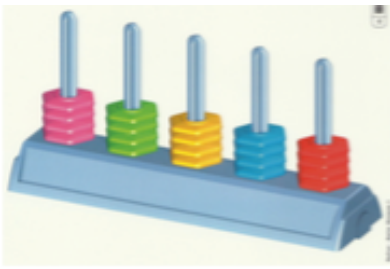

4

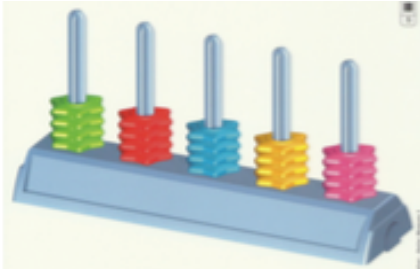

5

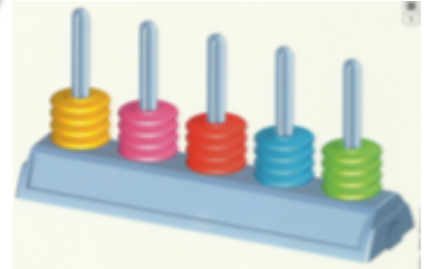

6

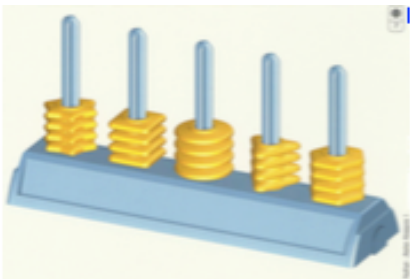

7

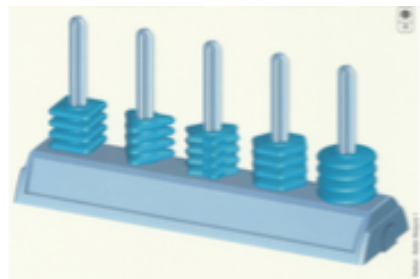

8

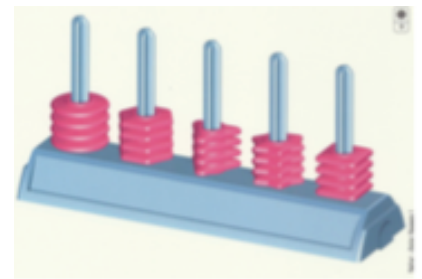

9

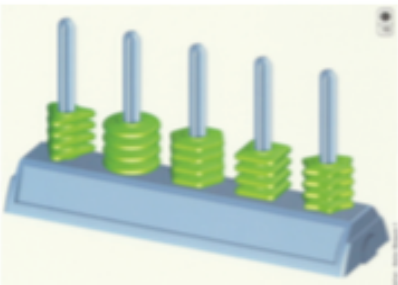

10

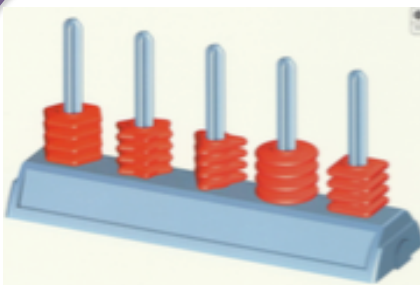

11

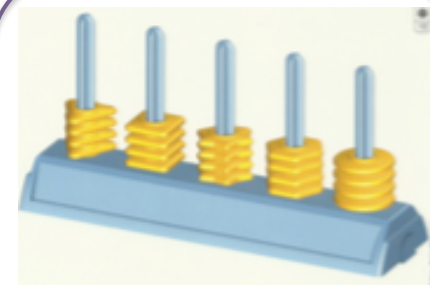

12

- Compétences :**
- Situer des objets dans l'espace, les uns par rapport aux autres
  - Différencier et trier des objets selon leur forme et leur couleur
  - Reproduire des agencements de formes de couleurs différentes en passant du plan horizontal au plan vertical).



# Défi ATELIER ABAQUES 1

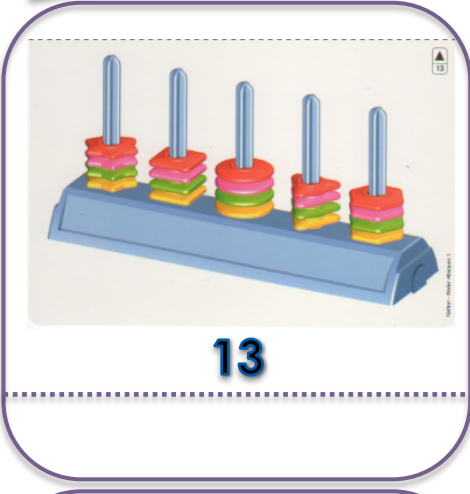

13

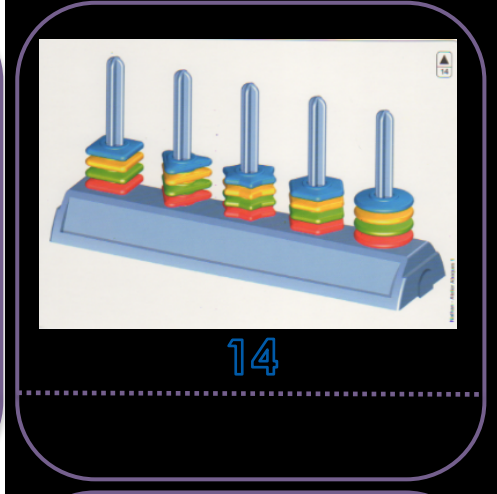

14

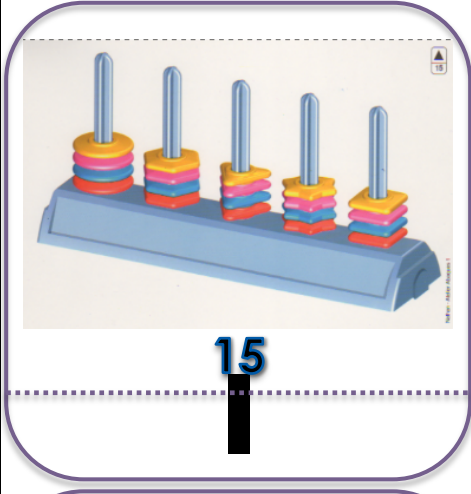

15

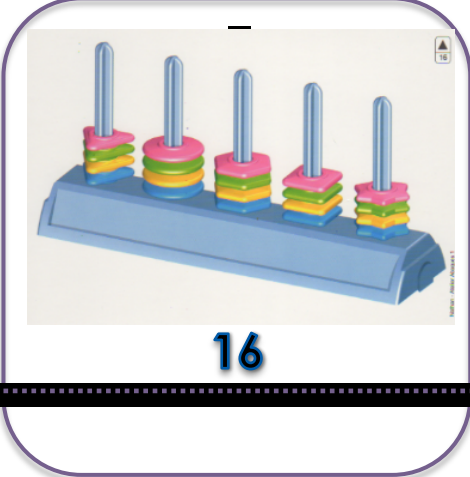

16

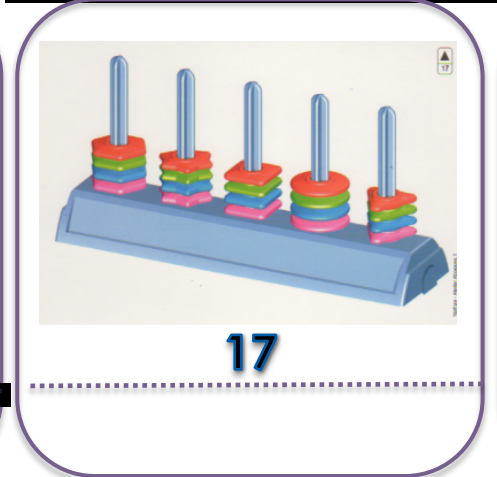

17

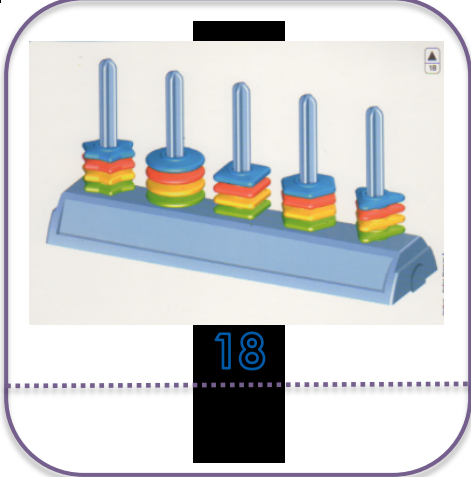

18



19

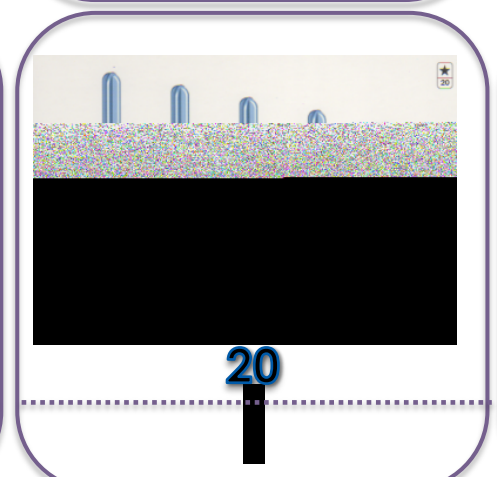

20

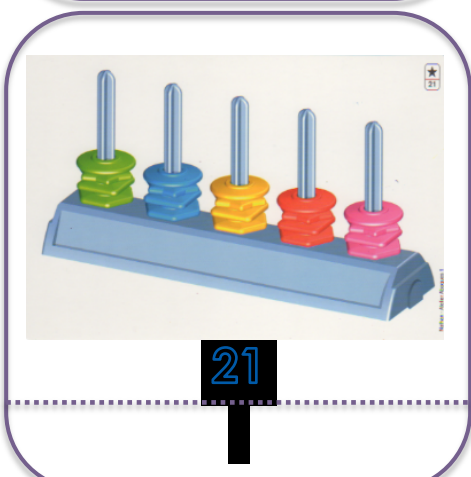

21



22



23



24

- Compétences :**
- Situer des objets dans l'espace, les uns par rapport aux autres
  - Différencier et trier des objets selon leur forme et leur couleur
  - Reproduire des agencements de formes de couleurs différentes en passant du plan horizontal au plan vertical).